



Intelligent Refractor  
**RT-6100**



THE ART OF EYE CARE



Elevated refraction



The RT-6100, a breakthrough refractor from NIDEK, will inspire you in unequalled refraction workflow. It is designed to help operators demonstrate creativity without compromising patient comfort.

The combination of a streamlined refractor head and user-friendly control console allows exceptionally precise and efficient examinations. Enhanced data communication functions strengthen the seamless network in diverse environments.

Integration of the RT-6100 into a refraction workstation COS-6100/610 with other NIDEK products, such as objective refraction devices, chart presenting devices, and lensmeters, creates a smoothly combined and efficient total eye examination solution.

Discover the power of a versatile and comprehensive refraction system that fulfills your present, and future needs - now.



### **Sleek form**

In pursuit of a superior experience for both patient and operator, the RT-6100 employs a honed ergonomic design. The streamlined shape makes a sophisticated impression.

### **Elegance in motion**

Extremely smooth, quiet and speedy lens changes ensure reliable and comfortable measurement without distraction.

### **Accurate results**

The clear blue LED forehead rest indicator helps to ensure correct patient position. A wide visual field of 40 degrees also provides greater visibility for patients, to consistently obtain accurate measurements.

### **Patient-friendly examination**

Comfortable forehead rest reduces patient discomfort and stress for a more stationary and relaxed examination position.

### **Convergence and pupillary distance**

During near vision test, convergence and pupillary distance are adjusted automatically.

### **Clear, white LED illumination**

Bright and energy efficient white LED illuminates the near chart for near vision test.



# Streamlined refractor head

Iconic design.

Extreme precision.

Advanced technology.

## Binocular open refraction

Seven different programs are available with the RT-6100. The binocular open refraction program, using fogging, takes measurements with more natural vision of patient, including the cross cylinder test.

## Tilting function for near vision check\* (optional)

Optional refractor head tilt unit enables a patient to look through the refractor head for near vision check.

\*Use the chart as reference only. For accurate measurement, use the supplied near point rod and near point chart.

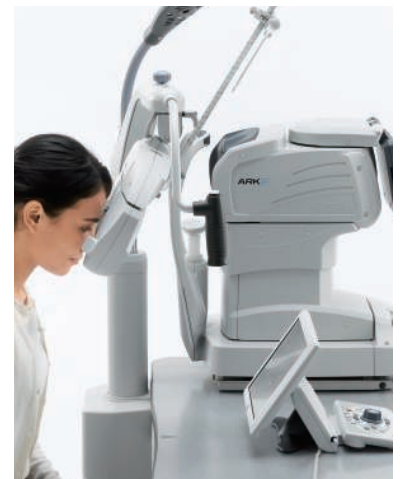

## Effortless maintenance

Antifogging protective glasses and detachable forehead rest / face shields facilitate simple cleaning.



## Polarization switching unit (optional)

By using the polarization switching unit, the RT-6100 corresponds to circular polarization. (The linear polarization filter is the default setting.)



# User-friendly control console

Comprehensive testing.

Intuitive interface.

High versatility.

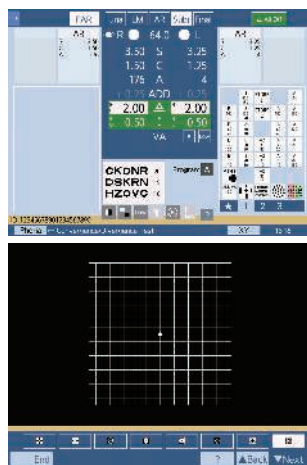

## Prism removal

Horizontal/vertical prism can be removed separately for more smooth and comfortable operation, and contributes to optimal prescriptions.

## Amsler grid drawing

Patients can draw their vision patterns on screen with a touch pen to depict how they visualize the chart.

## Clear vision range check

Clear vision range check supports a comprehensive explanation to patients. Based on measured values, it gives the patients a visual aid in a graphical form to demonstrate the range of clear vision with their correction in place.

## Favorite charts

If you bookmark the frequently used charts, you can rapidly select them later and further improve practice efficiencies.

## Displaying images

The images in the SD memory card can be displayed on the control console screen. A list of images is displayed as thumbnails for easy management.

## Program edit function

Examination program can be easily selected or customized with understandable screen displays and a flexible edit function, to meet any operator's needs.



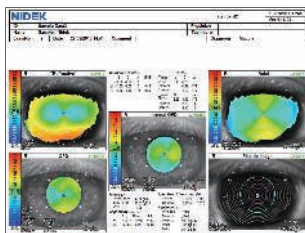
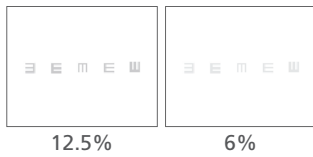
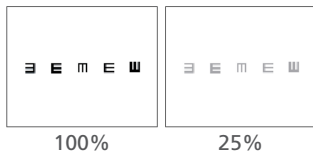

## Cross cylinder test

Cylinder power and axis can be adjusted easily with the touch of a button. Auto cross cylinder function helps patients to compare two charts simultaneously.

## Final Fit for the best fit prescription

The RT-6100 incorporates Final Fit, the adjusted power calculation program, to help find the most comfortable prescription for each patient.

## Contrast, black and white inversion functions\*1

The contrast test confirms the visual function with contrast sensitivity of patients who have undergone cataract or refractive surgery. For low vision patients, the black-white invertible VA chart is also available.\*2

## Night mode\*1

Some patients have different sphere, cylinder, and axis values between their day and night pupils. Night mode examines night-time visual acuity under low light conditions to correspond these patients.

## OPD-Scan III summary

NIDEK OPD-Scan III summary image can be displayed on the large control console screen, which is useful for a more comprehensive evaluation of a patient's optical path. This technology also enhances patient appreciation of the total examination experience.

\*1 The functions are available when connected to the system chart SC or space saving chart SSC. Available SSC types are limited.

\*2 VA value is for reference.

## Toggle dial

Measurement values are easily changed by turning the toggle dial. The button in the center of the dial allows operators to quickly switch between sphere, cylinder, and axis using only one hand. A logically arranged keypad enables intuitive operation while remaining engaged with every patient.

## 10.4-inch color LCD touch screen

The 10.4-inch color LCD touch screen displays a great deal of information including near chart images, refraction diagrams, eye diagram, and visual images as viewed through eyes with pathology.

## Reversible flip-display

The display can be flipped to the patient's side when used in near vision check or patient education.



# Simplified data transfer

NIDEK products work together to enhance productivity and communication in your practice. Seamless data transfer increases examination efficiency while maintaining high-quality performance.

## Connection configurations

The RT-6100 has various connection patterns according to usage.

Example 1

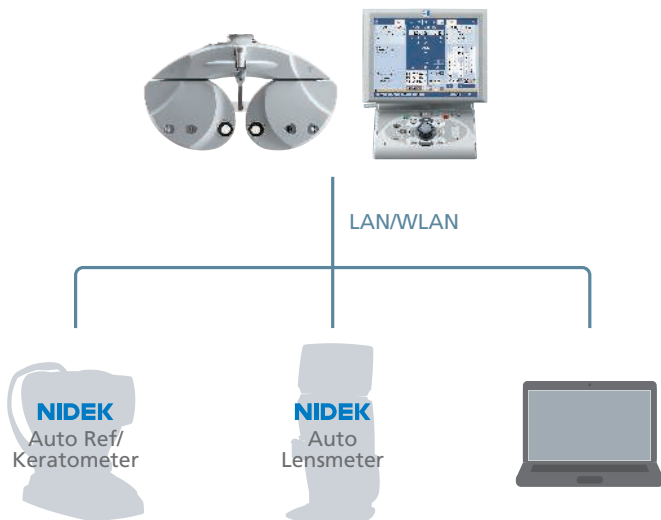

Example 2

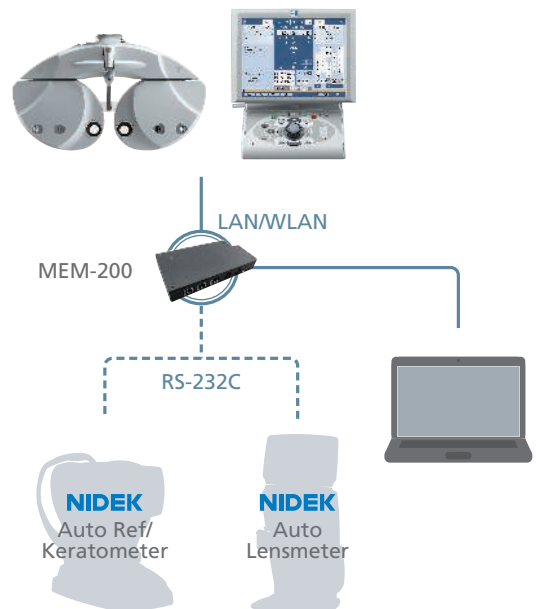



## Refraction

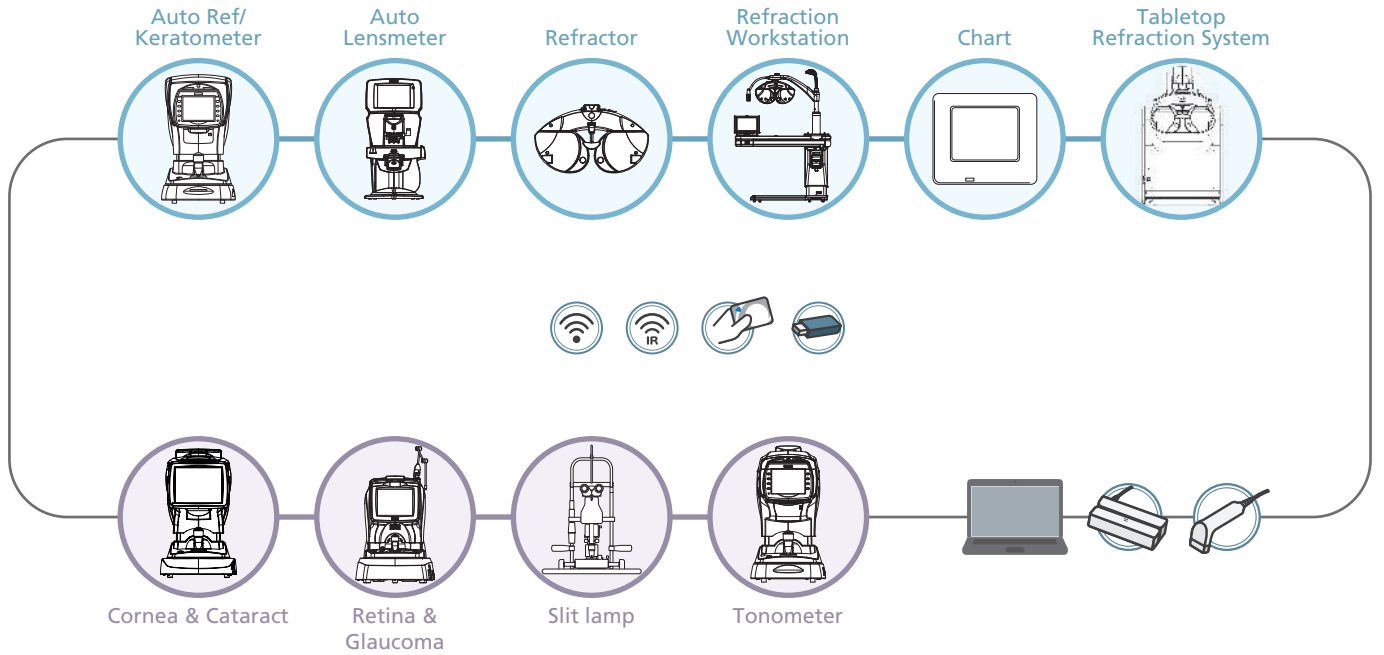

### Example 3

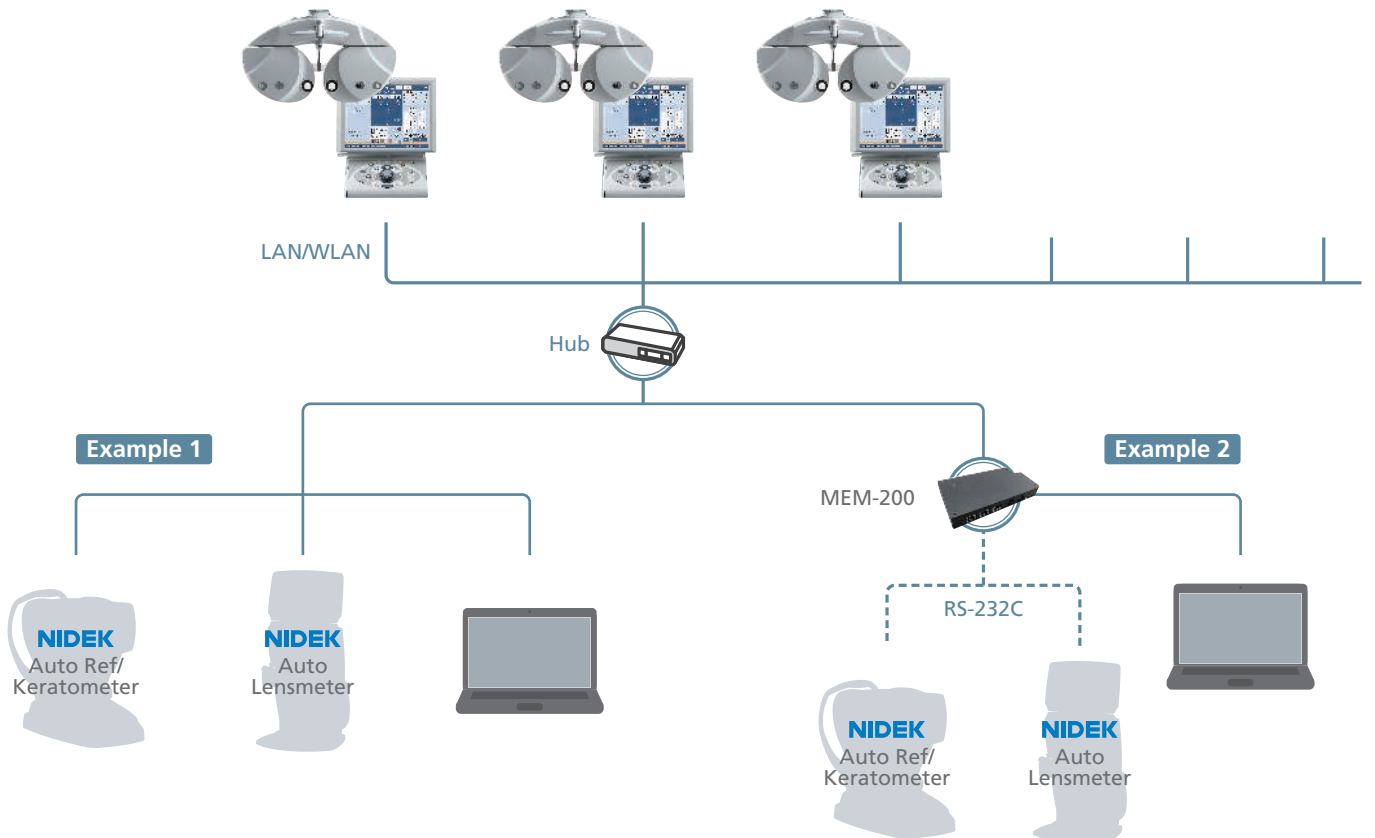

The specifications for data transfer differ according to each product. Please contact us for further information.

# Build your customized workstation

The RT-6100 can be integrated into the NIDEK COS-6100/610 refraction workstation with other NIDEK products including objective devices, LCD chart devices, and lensmeters. Numerous types of customized table options are available to satisfy your specific practice requirements.



## Optimized combinations

The COS series is designed to make your refraction experience more inspiring, enjoyable, and rewarding, by providing numerous instrument combinations from a broad product offering.

## Motorized table with safety mechanism

The main table provides excellent stability with silent, effortless vertical adjustment.



## Proven durable construction

The durable, practical design allows easy setup and creates comfortable examination space both for operator and patient. The simple but versatily designed workstations fit any space and aesthetically compliment NIDEK product designs for an attractive and functional addition to any facility.

## Safety one-touch lock arm

The refractor head smoothly slides back and forth in an arc. An arm release/position lock button improves the stability and safety of every examination.



## Drawers for trial lenses\*

Drawers space facilitates and expedites the selection and storage of trial lenses.

\*The trial lenses are not included or sold with the COS series.

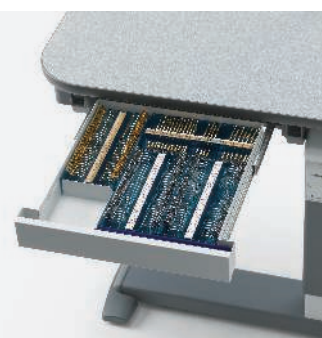

## COS-6100 Table (ST-6100)

### Complete performance packages

- All components of the refraction process
- Customizable optional accessories
- Side table for space saving chart and lensmeter
- Two-unit mounting tray for objective device and slit lamp

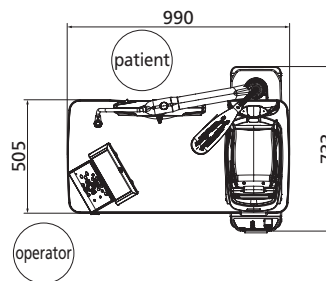
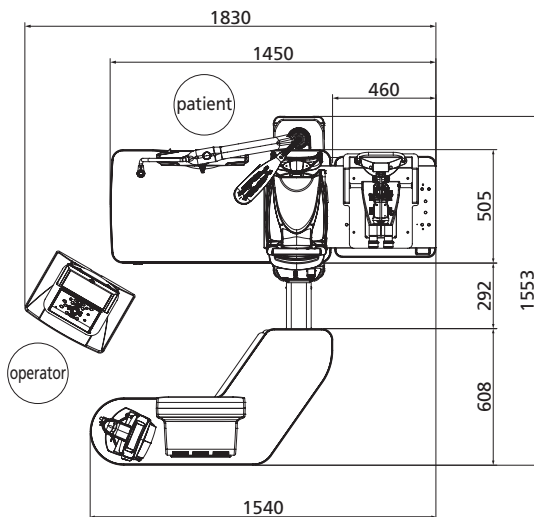

## COS-610 Table (ST-600)

### Workspace simplified

- Compact design to fit any facility
- Easy-to-transport, wheeled table
- Flexible room configurations

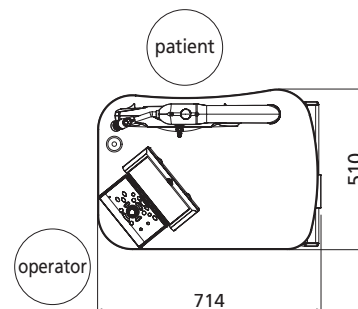

## COS-6100 Table (ST-6100) / COS-610 Table (ST-600) Specifications

Model	COS-6100 Table (ST-6100)	COS-610 Table (ST-600)
RT arm	Electromagnetic lock	←
Up-and-down of RT arm	Stroke 310 mm	-
Back-and-forth of RT arm	Stroke to patient side 230 mm	-
Power supply	100 to 120 V AC / 220 to 240 V AC, 50/60 Hz	120/230 V AC, 50/60 Hz
Power consumption	600 VA (max, including RT and other optometry device)	500 VA (max, including RT and other optometry device)
Standard accessories	Power cord, Fuse, Power cord for chart, Refractor head hanging bracket	←
Optional accessories	Side table R, Side table L, Two-unit mounting kit R, Two-unit mounting kit L, Conversion cable (for mounting OPD-Scan III), Takagi Slit Lamp one-unit mounting kit, MEM-200 mounting kit, SL-1800 mounting set (for two-unit mounting tray), SL-1800 mounting set (for one-unit mounting tray), AR-F/ARK-F mounting plate, OPD-Scan III mounting plate (for two-unit mounting tray), Manual RT mounting kit R, Manual RT mounting kit L, CP3B-19 kit, Tray for trial lenses	Manual RT mounting kit, Tray for trial lenses

# RT-6100 Specifications

Measurement range	
Sphere	-29.00 to +26.75 D (0.12/0.25/0.50 to 3.00 D increments) -19.00 to +16.50 D (cross cylinder test, prism test)
Cylinder	0.00 to ±8.75 D (0.25/1.00/2.00/3.00 D increments)
Axis	0 to 180° (1°/5°/15° increments)
PD	48 to 80 mm (far mode) 50 to 74 mm (near working distance of 35 cm) 54 to 80 mm (far PD possible for 100% convergence)
Prism	0.00 to 20.00Δ (0.1/0.5/2Δ increments)
Auxiliary lenses	
Cross cylinder lens	±0.25, ±0.50, ±0.25 D auto cross
Occluder	Available
Pinhole plate	ø2.0 mm
Red/green filter	Right eye: red, Left eye: green
PD check lens	Available
Polarizing filters	Right eye: 135° / Left eye: 45°, Right eye: 45° / Left eye: 135°
Fixed cross cylinder lens	±0.50 D (fixed with the Axis set at 90°)
Spherical lenses for retinoscope	0/+1.5/+2.0 D (selectable by setting)
Red maddox rod	Right eye: horizontal, Left eye: vertical
Dissociation prism	Right eye: 6ΔBU / Left eye: 10ΔBI
Dissociation prism for binocular balance*1	Right eye: 3 to 10ΔBD / Left eye: 3 to 10ΔBU
Dissociation prism for horizontal phoria*1	Right eye: 3 to 10ΔBU / Left eye: 3 to 10ΔBD
Dissociation prism for vertical phoria*1	Right eye: 5 to 15ΔBI / Left eye: 5 to 15ΔBI
Fixed cross cylinder & dissociation prism for horizontal phoria*1	Right eye: 3 to 10ΔBU / Left eye: 3 to 10ΔBD
Binocular open fogging	0.00 to +9.00 D
Visual field	40° (VD = 12 mm), 39° (VD = 13.75 mm)
Refraction distance for near vision	350 to 700 mm (50 mm increments)
Forehead rest adjustment	25±2 mm
Vertex distance marking	12, 13.75, 16, 18, 20 mm
Level adjustment	±2.5°
Display	10.4-inch color LCD
Printer	High speed line printer
Interface	RS-232C: 1 port for connection with chart presenting device USB: 1 port LAN: 3 ports Wireless LAN (WLAN)*2 (optional)
Power supply	100 to 240 V AC, 50/60 Hz
Power consumption	90 VA
Dimensions/mass	
Refractor head	408 (W) x 107 (D) x 277 (H) mm / 3.2 kg 16.1 (W) x 4.2 (D) x 10.9 (H)" / 7.1 lbs.
Control console	260 (W) x 230 (D) x 207 (H) mm / 2.1 kg 10.2 (W) x 9.1 (D) x 8.1 (H)" / 4.6 lbs.
Relay box	189 (W) x 221 (D) x 73 (H) mm / 1.4 kg 7.4 (W) x 8.7 (D) x 2.9 (H)" / 3.1 lbs.
Printer	101 (W) x 86 (D) x 121 (H) mm / 0.6 kg 4.0 (W) x 3.4 (D) x 4.8 (H)" / 1.3 lbs.
Standard accessories	Face shield, Forehead rest, Stylus pen, Printer paper, Dust cover, Near point chart, Near point rod, Knob, Power cord, Communication cable
Optional accessories	Eye Care card, Infrared communication unit, Refractor head tilt unit, Control console stand, Wireless LAN module, Magnetic card reader, Barcode scanner, Memory box, Polarization switching unit, Space Saving Chart SSC-100, Near point rod, Relay box - control console cable 10 m, LAN cable, RT-6100 CB for Windows

\*1 Changeable in increments of 0.5Δ for monocular measurement \*2 Only for the countries (regions) certified by the Radio Law

Product/model name: REFRACTOR RT-6100  
System Table ST-6100  
System Table ST-600

Brochure and listed features of the devices are intended for non-US practitioners.

Specifications may vary depending on circumstances in each country.

Specifications and design are subject to change without notice.

All LCD images are simulated.



**HEAD OFFICE**  
**(International Div.)**  
34-14 Maehama,  
Hiroishi-cho, Gamagori,  
Aichi 443-0038, JAPAN  
TEL: +81-533-67-8895  
URL: www.nidek.com

**TOKYO OFFICE**  
**(International Div.)**  
3F Sumitomo Fudosan Hongo  
Bldg., 3-22-5 Hongo, Bunkyo-ku,  
Tokyo 113-0033, JAPAN  
TEL: +81-3-5844-2641  
URL: www.nidek.com

**NIDEK INC.**  
2040 Corporate Court,  
San Jose, CA 95131, U.S.A.  
TEL: +1-408-468-6400  
+1-800-223-9044  
(US Only)  
URL: usa.nidek.com

**NIDEK S.A.**  
Ecoparc,  
9 rue Benjamin Franklin,  
94370 Sucy En Brie,  
FRANCE  
TEL: +33-1-49 80 97 97  
URL: www.nidek.fr

**NIDEK TECHNOLOGIES S.R.L.**  
Via dell'Artigianato,  
6/A, 35020 Albignasego (Padova),  
ITALY  
TEL: +39 049 8629200/8626399  
URL: www.nidektechnologies.it

**NIDEK (SHANGHAI) CO., LTD.**  
Rm3205, Shanghai Multi  
Media Park, No.1027 Chang  
Ning Rd, Chang Ning District,  
Shanghai, CHINA 200050  
TEL: +86 021-5212-7942  
URL: www.nidek-china.cn

**NIDEK SINGAPORE PTE. LTD.**  
51 Changi Business Park  
Central 2, #06-14,  
The Signature 486066,  
SINGAPORE  
TEL: +65 6588 0389  
URL: www.nidek.sg

[Manufacturer]